



## 1T10A1\_3UP series

1W - Dual Output DC-DC Converter - Fixed Input - Isolated & Unregulated

### DC-DC Converter

1 Watt

- ⊕ Short circuit protection (SCP)
- ⊕ Compact SMD package
- ⊕ 3kVDC Isolation
- ⊕ High efficiency up to 85%
- ⊕ Temperature Range: -40°C ~ +105°C
- ⊕ No-load input current as low as 8mA
- ⊕ Industry standard pinout
- ⊕ IEC62368, UL62368, EN62368 approved
- ⊕ RoHS compliance



Common specifications	
Short circuit protection:	Continuous, self-recovery
Operation temperature range:	-40°C~+105°C (Derating when operating temperature up to ≥ 100°C, see Fig. 2)
Storage temperature range:	-55°C ~+125°C
Case Temperature Rise:	25°C TYP (Ta = 25°C)
Storage humidity range:	5 ~ 95%RH, non-condensing
Reflow soldering temperature:*	Peak temp.≤245°C, maximum duration time≤60s over 217°C
Vibration:	10-150Hz, 5G, 0.75mm. along X, Y and Z
Pin welding resistance temperature:	300°C MAX, 1.5mm from case for 10 sec
MTBF (MIL-HDFK-217F@25°C):	>3,500,000 hours
Moisture Sensitivity Level (MSL):	IPC/JEDEC J-STD-020D.1 Level 1
Casing material:	Black plastic; flame-retardant and heat-resistant (UL94 V-0)
Cooling:	Free air convection
Dimensions:	15.24 x 11.40 x 7.25 mm
Weight:	1.4g Typ.

\*For actual application, please refer to IPC/JEDEC J-STD-020D.1.

Input specifications					
Item	Test condition	Min	Typ	Max	Units
Input current (full load / no load)	5V input		244/5	257/10	mA
	• 5V output		241/12	254/20	mA
	• 9/12V output		241/18	254/30	mA
	• 15V output				
Input current (full load / no load)	12V input				
	• ±5/±7.5VDC output		102/8	107/-	mA
	• ±9/±12/±15VDC output		101/8	106/-	mA
	• ±24VDC output		99/8	103/-	mA
	15V input				
	• ±24VDC output		81/8	85/-	mA
Input current (full load / no load)	24V input				
	• ±5/±9/±12/±15VDC output		51/8	55/-	mA
	• ±24VDC output		50/8	53/-	mA
Reflected ripple current*			15		mA
Surge voltage (1sec. max.)	12VDC input	-0.7		18	VDC
	15VDC input	-0.7		21	VDC
	24VDC input	-0.7		30	VDC
Input filter	Filter capacitor				
Hot plug	Unavailable				

\* Reflected ripple current testing method please see DC-DC Converter Application Notes for specific operation.

**Example:**  
**1T10A1\_0505D3UP**  
 1 = 1Watt; T10 = SMT10; A1 = Pinning; 05 = 5Vin; 05 = 5Vout;  
 D = Dual Output; 3 = 3kVDC; U = Unregulated Output;  
 P = Short Circuit Protection (SCP)

The 1T10A1\_3UP series are specially designed for applications where two isolated voltage is required in a distributed power supply system. They are suitable for: pure digital circuits, low frequency analog circuits, relay-driven circuits and data switching circuits.

Output specifications					
Item	Test condition	Min	Typ	Max	Units
Output accuracy	See output regulation curves (Fig. 1)				
Line regulation	Input voltage change: ±1%			±1.2	%
Load regulation	10% to 100% load:				
	• ±5VDC output		5	15	%
	• ±7.5VDC output		5	15	%
	• ±9VDC output		3	10	%
	• ±12VDC output		3	10	%
	• ±15VDC output		3	10	%
• ±24VDC output		2	10	%	
Ripple & noise*	20MHz Bandwidth		30	75	mVp-p
	• ±5/±7.5/±9/±12/±15VDC output				
• ±24VDC output		50	100	mVp-p	
Temperature coefficient	Full load		±0.02		%/°C
Switching frequency	Full load, nominal input		260		KHz

\* The "parallel cable" method is used for ripple and noise test, please refer to DC-DC Converter Application Notes for specific information.

Isolation specifications					
Item	Test condition	Min	Typ	Max	Units
Isolation voltage	Input-output, tested for 1 minute and 1mA max	3000			VDC
Isolation resistance	Input-output, isolation voltage 500VDC	1000			MΩ
Isolation capacitance	Input-output capacitance at 100kHz/0.1V		20		pF

EMC specifications					
EMI	CE	CISPR32/EN55032	CLASS B		
EMI	RE	CISPR32/EN55032	CLASS B		
EMS	ESD	IEC/EN61000-4-2	Air ±8kV, Contact ±6kV	perf. Criteria B	

Note: Refer to Fig.4 for recommended circuit test

#### Note:

- If the product is not operated within the required load range, the product performance cannot be guaranteed to comply with all parameters in the datasheet;
- The maximum capacitive load offered were tested at input voltage range and full load;
- Unless otherwise specified, parameters in this datasheet were measured under the conditions of Ta = 25°C, humidity <75%RH with nominal input voltage and rated output load;
- All index testing methods in this datasheet are based on our Company's corporate standards;
- We can provide product customization service, please contact our technicians directly for specific information;
- Products are related to laws and regulations: see „Features“ and „EMC“;
- Our products shall be classified according to ISO14001 and related environmental laws and regulations, and shall be handled by qualified units.

# 1T10A1\_3UP series

1W - Dual Output DC-DC Converter - Fixed Input - Isolated & Unregulated

## Product Selection Guide

Certification	Part Number	Input Voltage [VDC] Nominal (Range)	Output Voltage [VDC]	Output Current [mA; max/min]	Efficiency [%; typ/min]	Max. capacitive load* [μF, Max.*]
---	1T10A1_0505D3UP	5 (4.5-5.5)	±5	±100/±10	78/82	1200
---	1T10A1_0509D3UP	5 (4.5-5.5)	±9	±56/±6	79/83	470
---	1T10A1_0512D3UP	5 (4.5-5.5)	±12	±42/±5	79/83	220
---	1T10A1_0515D3UP	5 (4.5-5.5)	±15	±34/±4	79/83	220
UL	1T10A1_1205D3UP	12 (10.8-13.2)	±5	±100/±10	78/82	1200
---	1T10A1_1207D3UP	12 (10.8-13.2)	±7.5	±67/±7	78/82	470
UL	1T10A1_1209D3UP	12 (10.8-13.2)	±9	±56/±6	79/83	470
UL	1T10A1_1212D3UP	12 (10.8-13.2)	±12	±42/±5	79/83	220
UL	1T10A1_1215D3UP	12 (10.8-13.2)	±15	±34/±4	79/83	220
UL	1T10A1_1224D3UP	12 (10.8-13.2)	±24	±21/±3	81/85	100
UL	1T10A1_1515D3UP	15 (13.5-16.5)	±15	±34/±4	79/83	220
UL	1T10A1_2405D3UP	24 (21.6-26.4)	±5	±100/±10	76/82	1200
UL	1T10A1_2409D3UP	24 (21.6-26.4)	±9	±56/±6	77/83	470
UL	1T10A1_2412D3UP	24 (21.6-26.4)	±12	±42/±5	77/83	220
UL	1T10A1_2415D3UP	24 (21.6-26.4)	±15	±34/±4	77/83	220
UL	1T10A1_2424D3UP	24 (21.6-26.4)	±24	±21/±3	79/85	100

\* The specified maximum capacitive load for positive and negative output is identical.

## Typical characteristics

Output regulation curve

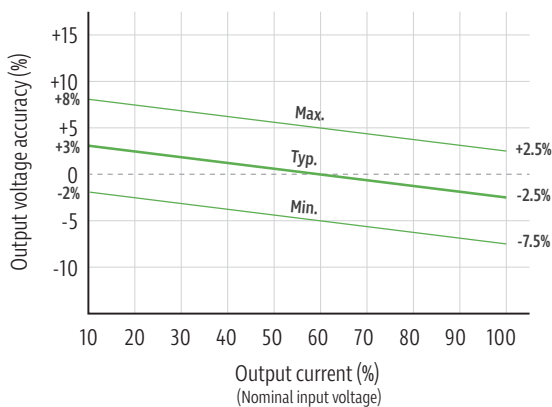

Temperature derating graph

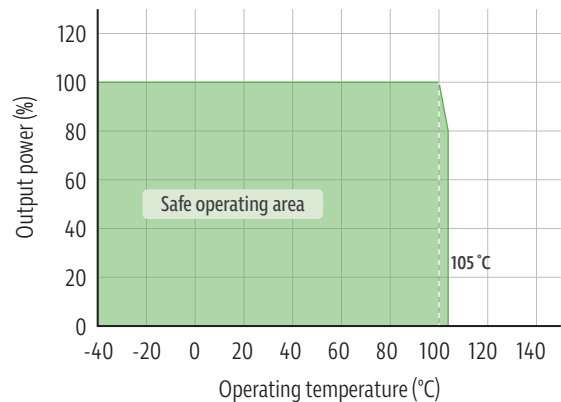

## Efficiency

Efficiency vs input voltage  
(Full load)

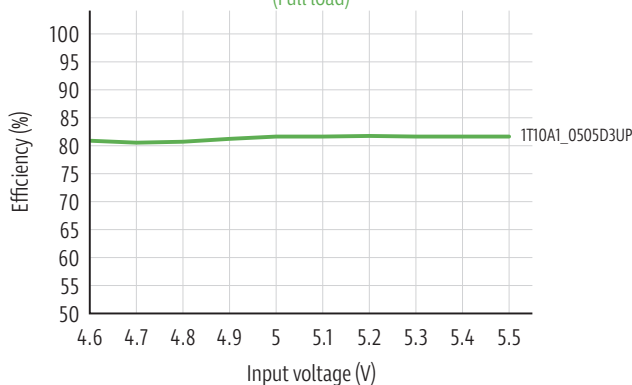

Efficiency vs output load  
(Vin = 5V)

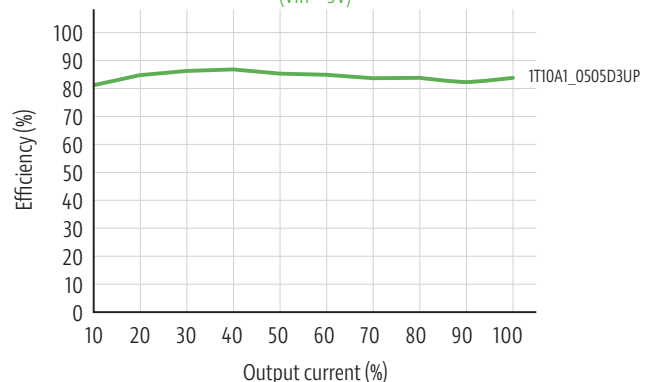

## 1T10A1\_3UP series

1W - Dual Output DC-DC Converter - Fixed Input - Isolated & Unregulated

### Efficiency

Efficiency vs input voltage

(Full load)

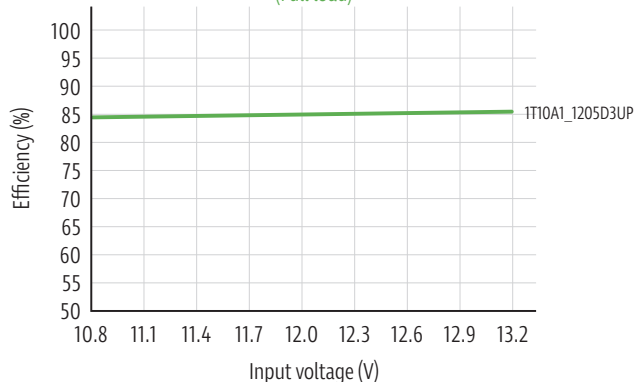

Efficiency vs output load

(Vin = 12V)

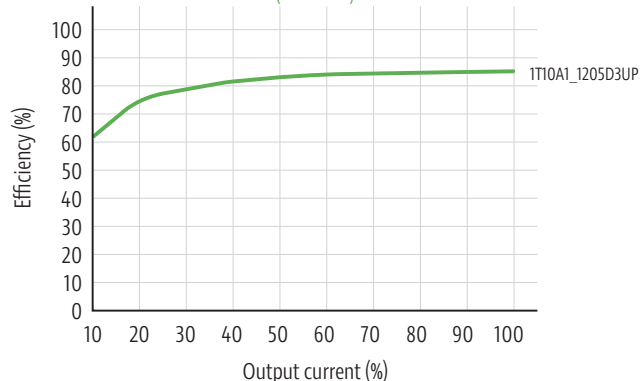

Efficiency vs input voltage

(Full load)

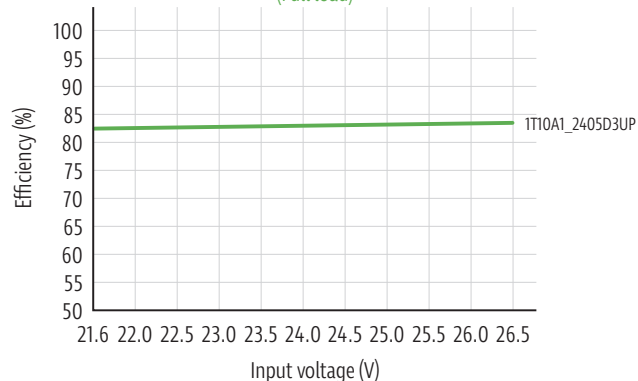

Efficiency vs output load

(Vin = 24V)

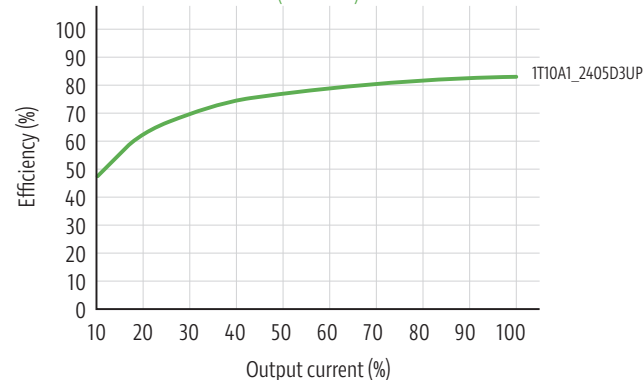

### Typical application circuit

If it is required to further reduce input and output ripple, a filter capacitor may be connected to the input and output terminals, see Fig.1.

Moreover, choosing a suitable filter capacitor is very important, start-up problems may be caused if the capacitance is too large. Under the condition of safe and reliable operation, the recommended capacitive load values are shown in Table 1.

The simplest device for output voltage regulation, over-voltage and over-current protection is a linear voltage regulator with overheat protection that is connected to the input or output end in series (see Fig. 2).



Fig. 1

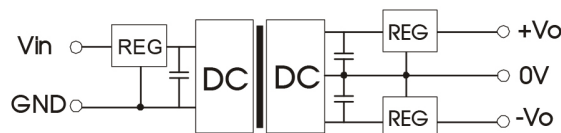

Fig. 2

Input and/or output ripple can be further reduced, by connecting a filter capacitor from the input and/or output terminals to ground as shown in Fig.3.

Choosing suitable filter capacitor values is very important for a smooth operation of the modules, particularly to avoid start-up problems caused by capacitor values that are too high. For recommended input and output capacitor values refer to Table 1.1.

Table 1 : Recommended capacitive load value table

Vin (VDC)	Cin (μF)	Vo (VDC)	Cout (μF)
5	4.7	±5	4.7
5	4.7	±9	2.2
5	4.7	±12	1
5	4.7	±15	1

Table 1.1: Recommended input and output capacitor values

Vin (VDC)	Cin (μF)	Vo (VDC)	Cout (μF)
12VDC	2.2μF/25V	±5VDC	4.7μF/16V
15VDC	2.2μF/25V	±7.5VDC	1μF/16V
24VDC	1μF/50V	±9VDC	1μF/16V
		±12VDC	1μF/25V
		±15VDC	0.47μF/25V
		±24VDC	0.47μF/50V

# 1T10A1\_3UP series

1W - Dual Output DC-DC Converter - Fixed Input - Isolated & Unregulated

## EMC solution-recommended circuit

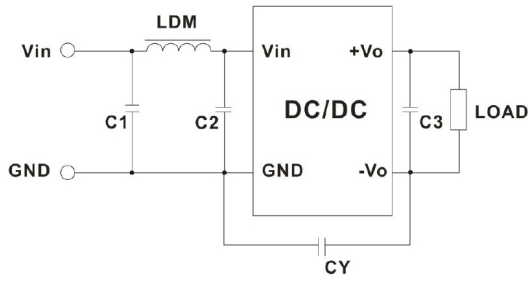

Table 2.1: EMC recommended circuit value table / input voltage 5VDC

Output voltage		5/9	12/15
EMI	C1/C2	4.7μF /25V	
	CY	--	1nF/2KVDC HEC C1206X102K202T JOHANSON 202R18W102KV4E
	C3	Refer to the Cout in table 1	
	LDM	6.8μH	

Note: In the case of actual use, the requirements for EMI are high, it is subject to CY.

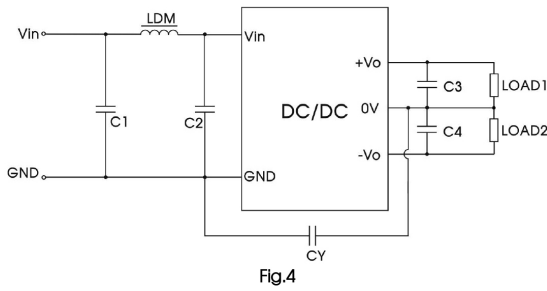
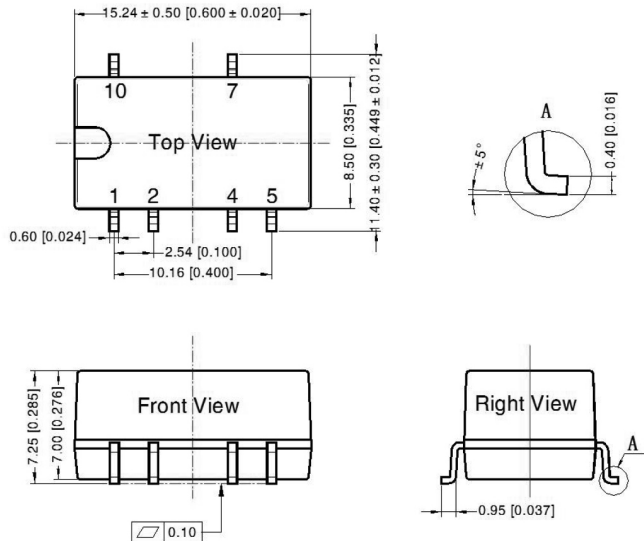

Table 2.2: EMC recommended circuit value table

Emissions	C1	4.7μF/50V
	C2	4.7μF/50V
	CY	270pF/3kV
	C3	Refer to the Cout in table 1
	C4	Refer to the Cout in table 1
	LDM	6.8μH

## Mechanical dimensions



Note:  
Unit: mm[inch]  
Pin section tolerances: ± 0.10[± 0.004]  
General tolerances: ± 0.25[± 0.010]

THIRD ANGLE PROJECTION

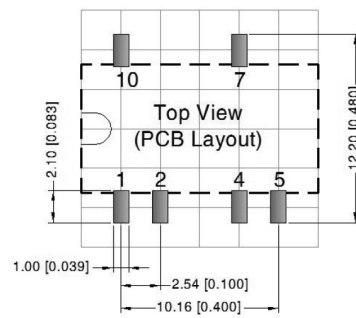

Note: Grid 2.54\*2.54mm

Pin-Out	
Pin	Mark
1	GND
2	Vin
4	0V
5	-Vo
7	+Vo
10	NC

NC: Pin to be isolated from circuitry

## 1T10A1\_3UP series

1W - Dual Output DC-DC Converter - Fixed Input - Isolated & Unregulated

### Tape and Reel Info

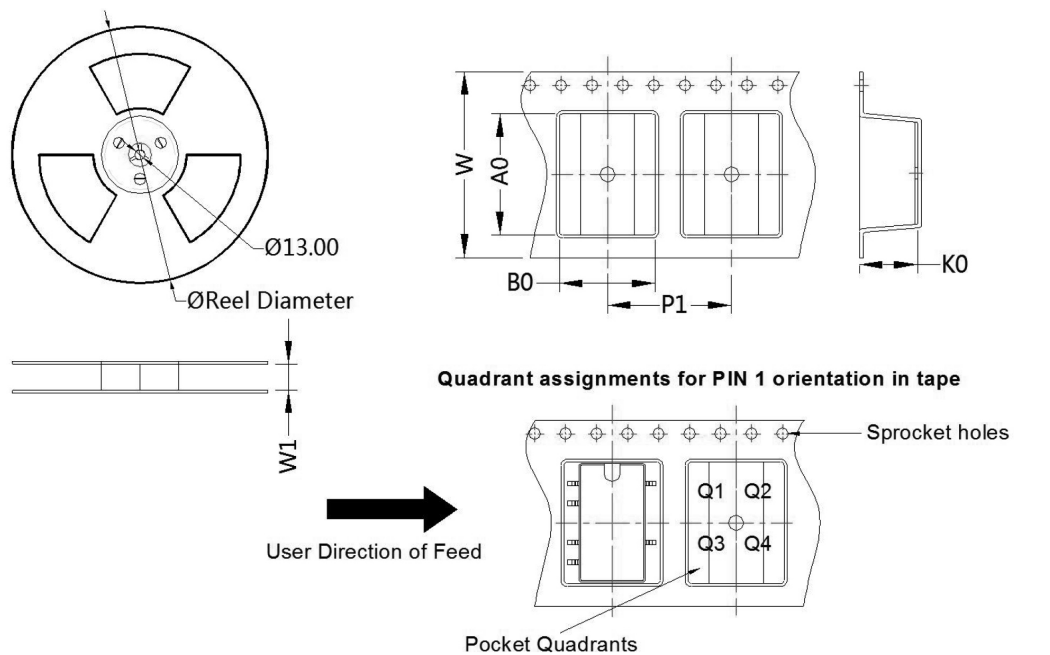

Package Type	Pin	SPQ	Reel Diameter (mm)	Reel Width W1 (mm)	A0 (mm)	B0 (mm)	K0 (mm)	P1 (mm)	W (mm)	Pin1 Quadrant
SMD	6	500	330.0	24.5	15.64	12.4	7.45	16.0	24.0	Q1