



3S6W4_3RP series

3W - Single/Dual Outputs - Wide Input - Isolated & Regulated DC-DC Converter

DC-DC Converter 3 Watt

- ⊕ Wide 4:1 input voltage range
- ⊕ Operating temperature range -40°C to +75°C
- ⊕ High efficiency up to 86%
- ⊕ 3W single and dual outputs
- ⊕ I/O isolation 1.6kVDC and 3kVDC option
- ⊕ Continuous short circuit protection remote ON/OFF
- ⊕ Control for single output only

The 3S6W4_3RP series is an excellent performance and high power density design, Wide 4:1 input voltage ranges: 4.5V-18V,9V-36V and 18V-75V. The highest efficiency allows -40°C to +75°C operating temperatures. The very low stand-by (no-load)input power consumption 50mW typ,makes them an ideal solution for application in battery-powered equipment and instrumentation.



Common specifications

Short circuit protection:	Continuous
Operation temperature range:	-40°C to +75°C
Case temperature:	100°C MAX
Storage temperature range:	-55°C ~+125°C
Lead Temperature	300°C max. 1.5mm from case for 10 sec
Storage humidity range:	< 95%
Operating Frequency	150kHz Min
MTBF:	>1310000 hours (MIL-HDBK-217F@25°C) >1870000 hours (MIL-HDBK-217F@71°C)
Packing Quantity	30 pcs per Tube
Potting Material	Epoxy [UL94-V0]
Case material:	Non-conductive black plastic [UL94-V0]
Weight:	3.5g
Dimension:	17 x 9.2 x 11.7mm

Input specifications

Item	Test condition	Min	Typ	Max	Units
Input Voltage Range	4.5-18V,9-36V, 18-75V			4:1	
Input filter	Capacitor				
Remote on/off	<ul style="list-style-type: none"> • ON (leave open if not used) • OFF (Series a 1KΩ Resistor) 	2	Open	4	mA

Isolation specifications

Item	Test condition	Min	Typ	Max	Units
Isolation voltage	1 second	3000			VDC
Isolation resistance	500VDC, input to output	1500			MΩ
Isolation capacitance	100KHz tested		30		pF

Output specifications

Item	Test condition	Min	Typ	Max	Units
Voltage accuracy	Nominal Vin and full load		±2		%
Line regulation	Vin=min to max,full load		±0.5		%
Load regulation	20% to 100% load		±0.5		%
Temperature coefficient	- 40°C to +85°C ambient		0.015		%/°C
Ripple&Noise	20MHz bandwidth		60		mVp-p
No Load Power Consumption		50		150	mW
Operating Frequency		150			kHz

Example:

3S6W4_1205S3RP

3 = 3Watt; S6 = SIP6; W4 = 4:1 Wide input; 4.5-18Vin; 12 = 12Vout; S = Single Output; 1.6 = 1600VDC isolation; R = Regulated Output; P = Short Circuit Protection

Note:

1. Recommended used in more than 5% load, if the load is lower than 5%, then the ripple index of the product may exceed the specification, but does not affect the reliability of the product;
2. The max. capacitive load should be tested within the input voltage range and under full load conditions;
3. Unless otherwise specified, data in this datasheet should be tested under the conditions of Ta = 25°C, humidity <75%RH, when inputting nominal voltage and outputting rated load;
4. All index testing methods in this datasheet are based on our Company's corporate standards;
5. We can provide product customization service;
6. Specifications of this product are subject to changes without prior notice.

3S6W4_3RP series

3W - Single/Dual Outputs - Wide Input - Isolated & Regulated DC-DC Converter

Product Selection Guide

Part Number	Input Voltage [VDC]		Output Voltage [VDC]	Output Current [mA, Max]	Capacitive load [μ F, Max.]	Efficiency [%, Typ.]
	Nominal	Range				
3S6W4_1203S3RP	12	4.5-18	3.3	600 mA	1000 μ F	78%
3S6W4_1205S3RP	12	4.5-18	5	600 mA	1000 μ F	82%
3S6W4_1212S3RP	12	4.5-18	12	250 mA	470 μ F	85%
3S6W4_1215S3RP	12	4.5-18	15	200 mA	330 μ F	85%
3S6W4_2403S3RP	24	9-36	3.3	600 mA	1000 μ F	79%
3S6W4_2405S3RP	24	9-36	5	600 mA	1000 μ F	83%
3S6W4_2412S3RP	24	9-36	12	250 mA	470 μ F	85%
3S6W4_2415S3RP	24	9-36	15	200 mA	330 μ F	85%
3S6W4_4803S3RP	48	18-75	3.3	600 mA	1000 μ F	80%
3S6W4_4805S3RP	48	18-75	5	600 mA	1000 μ F	83%
3S6W4_4812S3RP	48	18-75	12	250 mA	470 μ F	85%
3S6W4_4815S3RP	48	18-75	15	200 mA	330 μ F	85%

Part Number	Input Voltage [VDC]		Output Voltage [VDC]	Output Current [mA, Max]	Capacitive load [μ F, Max.]	Efficiency [%, Typ.]
	Nominal	Range				
3S6W4_1205D3RP	12	4.5-18	\pm 5	\pm 300 mA	\pm 470 μ F	82%
3S6W4_1212D3RP	12	4.5-18	\pm 12	\pm 125 mA	\pm 100 μ F	84%
3S6W4_1215D3RP	12	4.5-18	\pm 15	\pm 100 mA	\pm 47 μ F	85%
3S6W4_2405D3RP	24	9-36	\pm 5	\pm 300 mA	\pm 470 μ F	84%
3S6W4_2412D3RP	24	9-36	\pm 12	\pm 125 mA	\pm 100 μ F	86%
3S6W4_2415D3RP	24	9-36	\pm 15	\pm 100 mA	\pm 47 μ F	86%
3S6W4_4805D3RP	48	18-75	\pm 5	\pm 300 mA	\pm 470 μ F	83%
3S6W4_4812D3RP	48	18-75	\pm 12	\pm 125 mA	\pm 100 μ F	85%
3S6W4_4815D3RP	48	18-75	\pm 15	\pm 100 mA	\pm 47 μ F	85%

Typical Characteristic Curves

Temperature derating graph

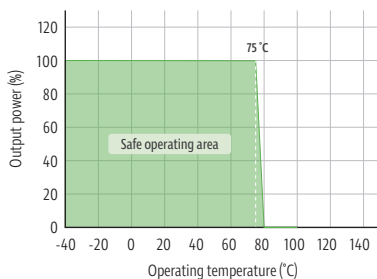

Functional Block Diagram

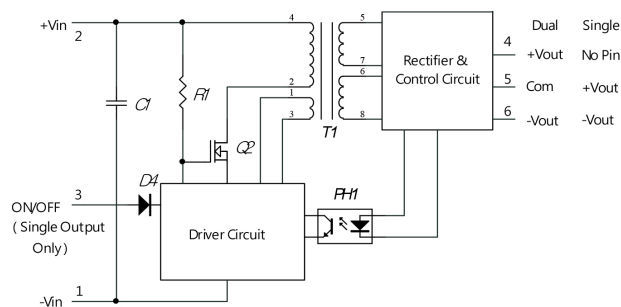

Tube Outline Dimensions (mm)

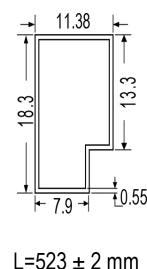

Remote On/ Off Control

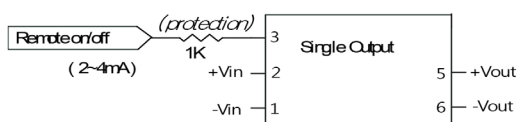

3S6W4_3RP series

3W - Single/Dual Outputs - Wide Input - Isolated & Regulated DC-DC Converter

Efficiency

Efficiency vs load
(Single)

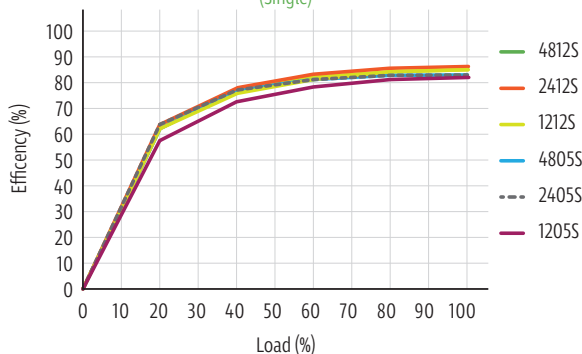

Efficiency vs vin
(Single)

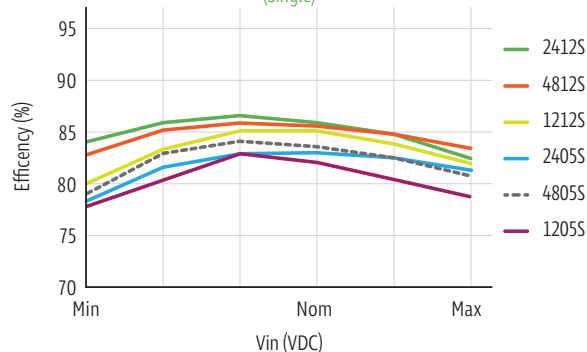

Efficiency vs load
(Single)

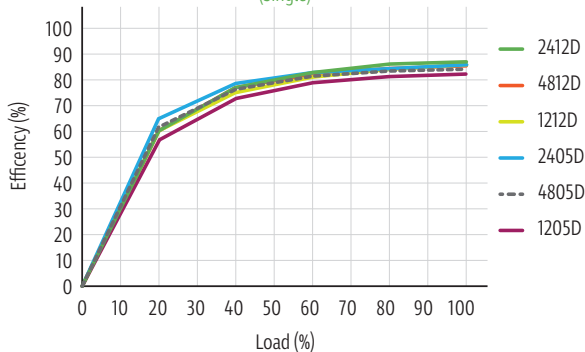

Efficiency vs vin
(Single)

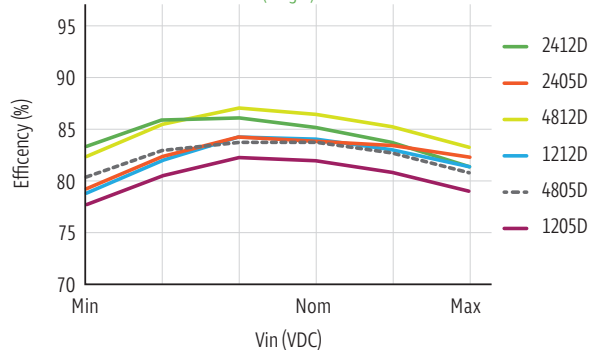

Package Style and Pinning

